

**Instructions for Use
CABLIVI® (cab-LIV-ee)
(caplacizumab-yhdp)
for injection
Single-dose vial**

Be sure that you read, understand, and follow this Instructions for Use before you inject CABLIVI and each time you get a refill. There may be new information. Your healthcare provider should show you how to prepare and inject CABLIVI properly before your first injection. Talk to your healthcare provider if you have any questions.

Important Information You Need to Know Before Injecting CABLIVI:

- Make sure that the name CABLIVI appears on the carton and vial label.
- For each injection, one CABLIVI carton is needed. Only use the vial one time.
- Only use the supplies that are provided in the carton to prepare your prescribed dose.
- **Do not use CABLIVI after the expiration date on the carton.**
- **Do not reuse any of the supplies.** After your injection, throw away (dispose of) the used vial with any remaining CABLIVI liquid in it. Throw away (dispose of) the used vial with the adapter attached and the syringe with the needle attached in an FDA-cleared sharps disposal container. See “Step 13: Throw away (dispose of) the used syringe and vial” at the end of this Instructions for Use for more disposal information.

How should I store CABLIVI?

- Store CABLIVI in the refrigerator between 36°F to 46°F (2°C to 8°C).
- Store CABLIVI in the original carton to protect from light.
- **Do not freeze CABLIVI.**
- Unopened CABLIVI vials may be stored at room temperature up to 86°F (30°C) in the original carton for a single period of up to two months. Write the date removed from the refrigerator in the space provided on the carton.
- **Do not return CABLIVI to the refrigerator** after it has been stored at room temperature.
- Use the mixed CABLIVI solution immediately. The mixed CABLIVI solution can be stored for up to 4 hours in the refrigerator at 36°F to 46°F (2°C to 8°C).
- **Keep CABLIVI and all medicines out of the reach of children.**

Each CABLIVI carton contains:

- 1 vial of CABLIVI
- 1 prefilled syringe containing 1 mL Sterile Water for Injection, USP (diluent for CABLIVI)
- 1 sterile vial adapter
- 1 sterile needle
- 2 alcohol swabs

Additional supplies needed:

- FDA-cleared sharps disposal container
- Cotton balls

Contents of CABLIVI carton

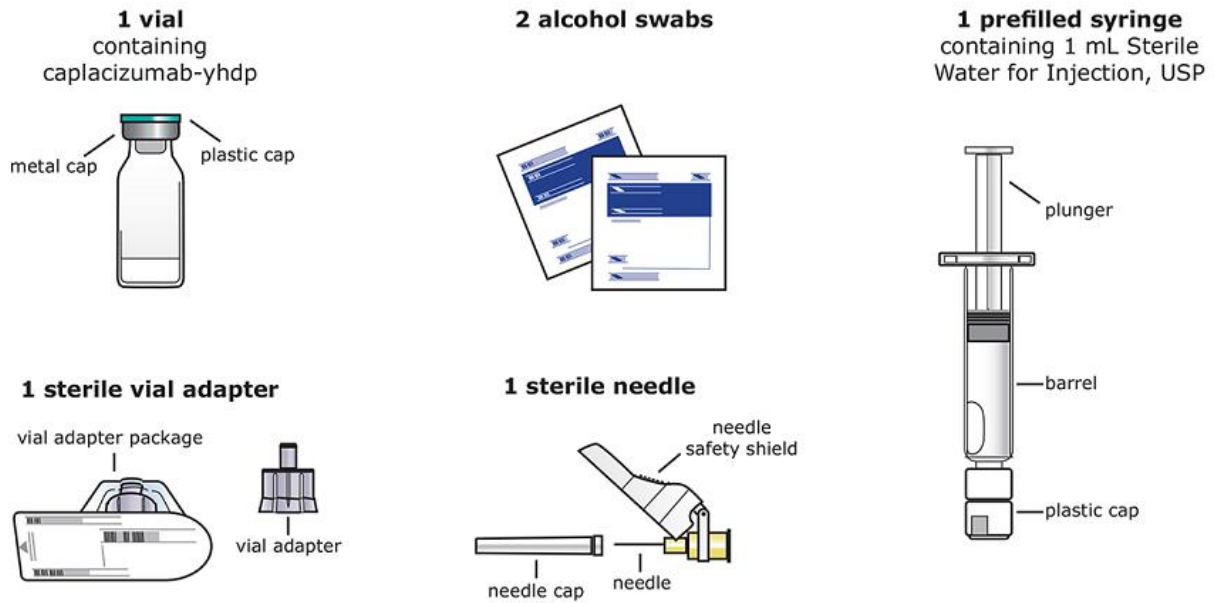

Additional supplies needed (not in CABLIVI carton)

Cotton balls

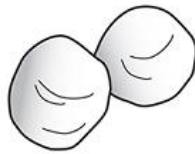

Sharps disposal container



Before preparing a dose of CABLIVI:

- Wash your hands well with soap and water.
- Prepare a clean flat surface.
- Check to make sure the carton contains all of the items needed to prepare a dose.
- Check the expiration date (**See Figure A**). **Do not use CABLIVI if the date has passed.**
- Do not use CABLIVI if the packaging or any supplies inside of the carton are damaged in any way.

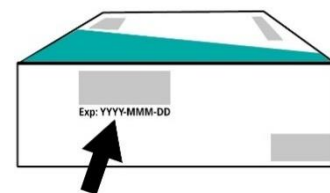

Figure A

Step 1: Bring the vial and syringe to room temperature

- Place all the supplies in the carton on the clean flat surface.
- If the carton was not stored at room temperature, allow the vial and the syringe to reach room temperature by holding them in your hands for 10 seconds (**See Figure B**). **Do not use any other way to warm up the vial and syringe.**

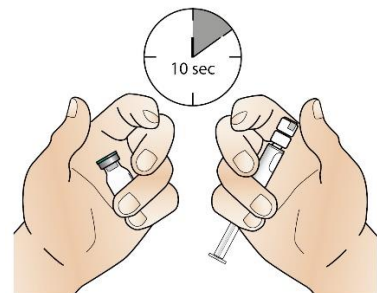

Figure B

Step 2: Clean the rubber stopper

- Remove the green plastic flip-off cap from the metal cap of the vial (**See Figure C**). **Do not use the vial if the green plastic cap is missing.**

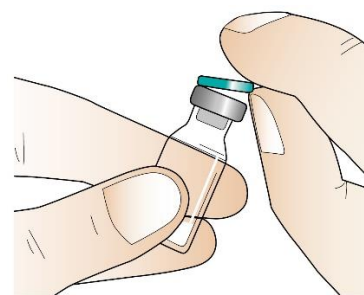

Figure C

- Clean the exposed rubber stopper using one alcohol swab to wipe it and allow it to dry for a few seconds (**See Figure D**).
- After cleaning the rubber stopper, do not touch it or allow it to touch any surface.

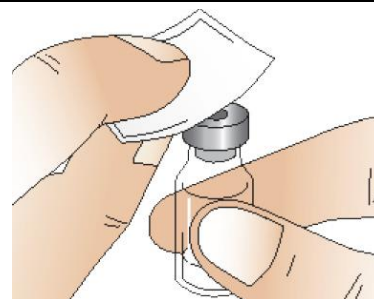

Figure D

Step 3: Attach the vial adapter

- Take the vial adapter and remove the paper cover (**See Figure E**). Leave the vial adapter in its opened plastic packaging for now. Do not touch the adapter itself.

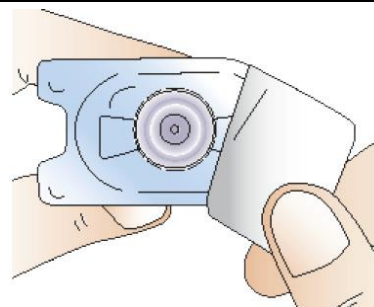

Figure E

- **Place the adapter over the vial, while keeping the adapter in its plastic packaging.**
- Press down firmly on the adapter until it snaps into place, with the adapter spike pushing through the vial stopper (**See Figure F**). Do not remove the adapter from the vial once attached.
- **Keep the adapter in its plastic packaging.**

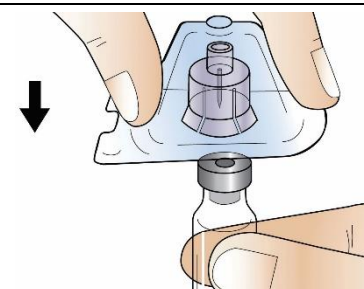

Figure F

Step 4: Prepare the syringe

- Pick up the syringe.
- While holding the syringe with one hand, break off the white plastic cap by snapping at the perforation of the cap with your other hand (**See Figure G**).
- **Do not use the syringe if the white plastic cap is missing, loose, or damaged.**
- **Do not touch the syringe tip or allow it to come into contact with any surfaces.**
- Lay the syringe on the clean flat surface.

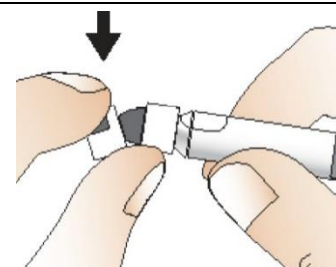

Figure G

Step 5: Connect the syringe to adapter and vial

- Remove the plastic packaging from the adapter attached to the vial by holding the vial with one hand, pressing the sides of the adapter packaging with your other hand, and then lifting the packaging upwards (**See Figure H**).
- Be sure that the adapter does not detach from the vial.

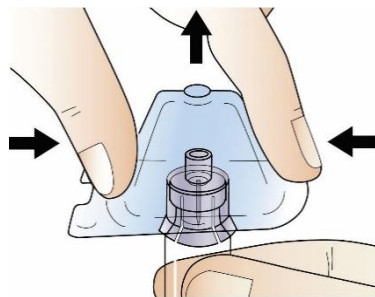

Figure H

- Hold the adapter with the attached vial with one hand. Place the tip of the syringe on the connector part of the vial adapter using the other hand.
- Gently lock the syringe into the vial adapter by turning it clockwise **until it cannot twist any further** (**See Figure I**).

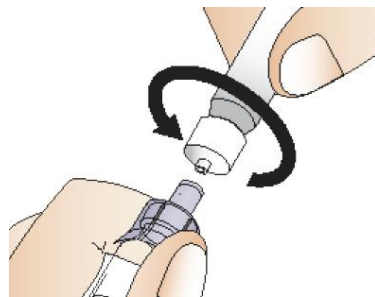

Figure I

Step 6: Prepare the solution

- Place the vial upright on the flat surface with the syringe pointing downwards.
- Slowly push the syringe plunger down until the syringe is empty (**See Figure J**). **Do not remove the syringe from the vial adapter.**

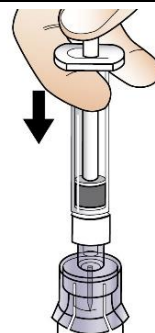

Figure J

- With the syringe still connected to the vial adapter, gently swirl the vial, with syringe attached, until the powder is dissolved in the vial (**See Figure K**). **Do not shake the vial.**



Figure K

- Allow the vial with the attached syringe to stand on the flat surface for **2 minutes** at room temperature to allow the powder to completely dissolve (**See Figure L**). The plunger may rise up by itself again, this is normal.

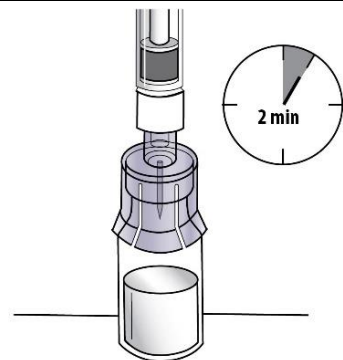

Figure L

Step 7: Draw up solution

- Check the solution in the vial for particles, cloudiness, or clumps. All powder must be fully dissolved and the solution must be clear. **Do not use the medicine if you see particles, cloudiness, or clumps.** Use a new carton of CABLIVI or call your healthcare provider.
- Slowly press the syringe plunger fully down.
- Keep the syringe on the vial and turn the vial, adapter and syringe upside down.
- Slowly pull the plunger down to withdraw all of the solution from the vial into the syringe (**See Figure M**). **Do not shake it.**

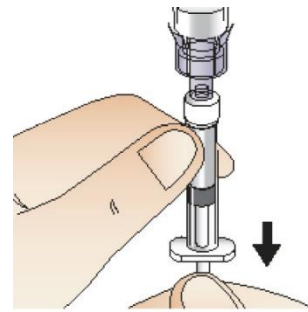

Figure M

Step 8: Detach the syringe

- After drawing up the solution into the syringe, turn the vial, adapter and syringe back to the starting position and place on the flat surface (**See Figure N**).

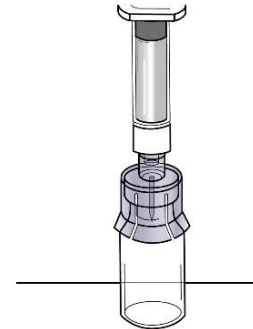

Figure N

- Detach the filled syringe from the adapter by holding the vial and adapter in one hand and gently twisting the syringe counter-clockwise with the other hand (**See Figure O**).
- Throw away the vial and the attached adapter into a sharps disposal container.
- Do not touch the syringe tip or allow it to touch the clean flat surface. Place the syringe on the clean flat surface.



Figure O

Step 9: Attach the needle

- Open the needle package by using both thumbs to pull apart the packaging (**See Figure P**).
- Remove the needle from the package.

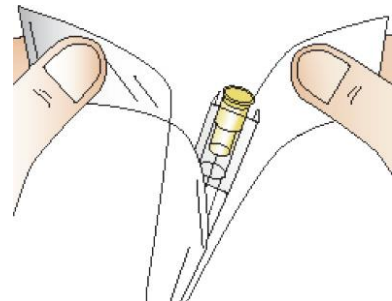

Figure P

- Attach the needle with the needle cap to the syringe by turning clockwise **until it cannot twist any further** (**See Figure Q**). **Do not remove the needle cap.**

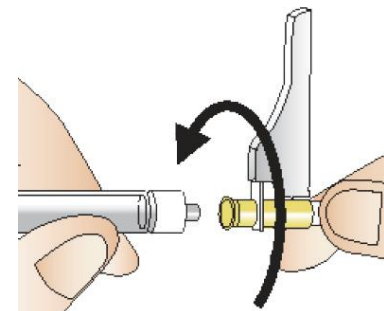

Figure Q

- Pull back the needle safety shield (**See Figure R**).

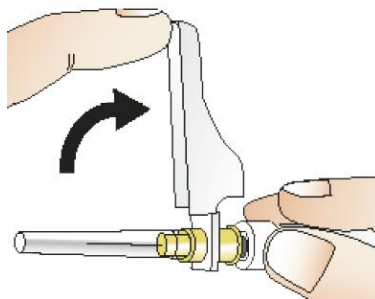

Figure R

Step 10: Prepare your injection site

- Select an injection site on your stomach (abdomen) (**See Figure S**). Avoid the 2-inch area around your belly button (navel). It is important to avoid injecting in the same site on your abdomen that you used for a previous injection on consecutive days.

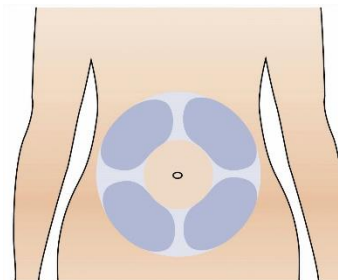

Figure S

- Clean your injection site with an alcohol swab (**See Figure T**). Let your skin dry.

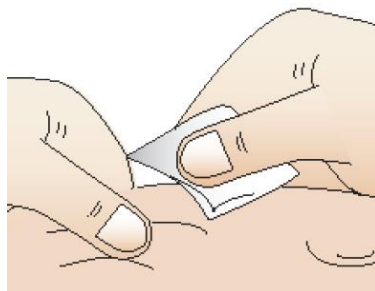

Figure T

Step 11: Giving your injection

- Carefully remove the needle cap from the needle and throw it away in a sharps disposal container (**See Figure U**). Make sure the needle does not touch anything before the injection.

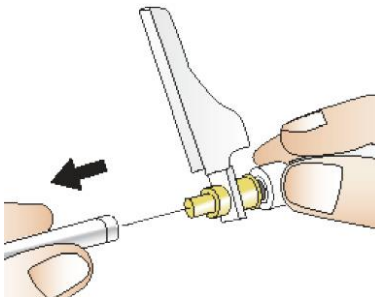

Figure U

- Hold the syringe at eye level with the needle pointing upwards.
- Check to see if there are any air bubbles. If there are any air bubbles, remove them by tapping the side of the syringe with your finger until they rise towards the tip (**See Figure V**).

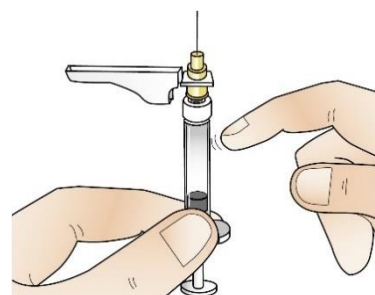

Figure V

- Then, slowly push the plunger up until a small amount of liquid drips from the needle (**See Figure W**).

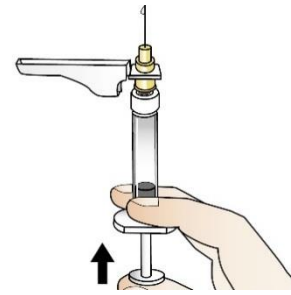

Figure W

- Gently use one hand to pinch the skin that has been cleaned between your thumb and forefinger, making a fold (**See Figure X**).
- Hold the pinch during the entire injection.

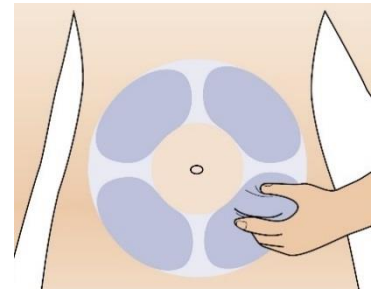

Figure X

- Use your other hand to insert the needle all the way into your skin fold at a 45 to 90-degree angle (**See Figure Y**).
- Push down on the plunger of the syringe until all of the solution is injected into your skin.
- Pull out the needle at the same angle you inserted it. Do not rub your injection site.

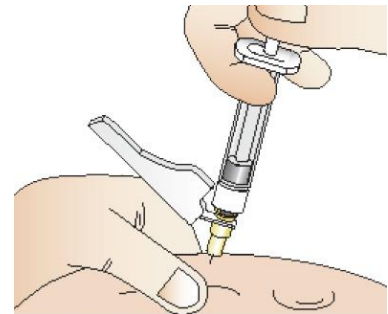

Figure Y

Step 12: After your injection

- Right after your injection, move the needle safety shield over the needle until it clicks into place to activate the shield (**See Figure Z**).
- In case you are bleeding at the injection site, place a cotton ball over the skin right away. Press gently on the cotton ball until the bleeding has stopped. If bleeding does not stop, call your healthcare provider.
- If your injection site becomes red or sore, call your healthcare provider right away.

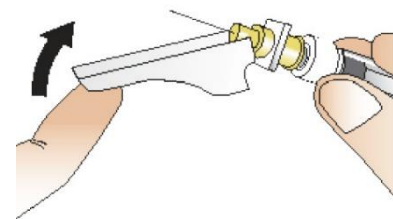

Figure Z

Step 13: Throw away (dispose of) the used syringe and vial.

- Always throw away the syringe with the needle and the vial with the adapter in an FDA-cleared sharps disposal container right away after use. Do not throw away (dispose of) loose needles and syringes with your household trash.
- If you do not have an FDA-cleared sharps disposal container, you may use a household container that:
 - is made of a heavy-duty plastic,
 - can be closed with a tight-fitting, puncture-resistant lid, without sharps being able to come out,
 - is upright and stable during use,
 - is leak-resistant, and
 - is properly labeled to warn of hazardous waste inside the container.
- When your sharps disposal container is almost full, you will need to follow your community guidelines for the right way to dispose of your sharps disposal container. There may be state or local laws about how you should throw away used needles and syringes. For more information about safe sharps disposal, and for specific information about sharps disposal in the state in which you live, go to the FDA's website at: <http://www.fda.gov/safesharpsdisposal>.
- Do not dispose of your used sharps disposal container in your household trash unless your community guidelines permit this.
- Do not recycle your used sharps disposal container.

This Instructions for Use has been approved by the U.S. Food and Drug Administration.

Manufactured by:
Ablynx N.V.
Technologiepark 21

9052 Ghent (Zwijnaarde), Belgium
A SANOFI COMPANY
U.S. License No. 2085

Distributed by:
Genzyme Corporation
Cambridge, MA 02141
A SANOFI COMPANY

Revised October 2024